



OTSXCEN4
BALANCE CONTOUR BENCH
contour expanded steel bench with
cast aggregate end panels, and
plastic armrests

Material

The bench seat is 4' long and made of 3/4 #9 expanded steel with a diamond shape pattern. The seat is plastisol coated with an average thickness of .125" and finished with a high-gloss patented TopCoat®. The bench seat will support 200 lbs per linear foot.

The bench end panels are cast aggregate and feature plastic armrests. They are designed to be portable, allowing for flexibility in placement.

Finish

The steel bench features a patented TopCoat, high-gloss finish which resists UV deterioration, mildew, staining and fading.

The TopCoat finish has been tested to the requirements of ASTM E 1354 and is determined to be in compliance with California Uniform Fire Code 1103.2.1.4.2.

The aggregate is cast in a durable epoxy resin that remains clear and bright throughout its life.

Color

Stone structures are available in Alpine Red, Black Lustre, Coffee Bean, Golden Glo, Mica, or Riverrock.

Steel bench components are available in Black, Brown, or Green.

Plastic armrests are available in Black or Chocolate.

Assembly

The bench requires some assembly.

Maintenance

Maintenance-free. To clean, spray with a power washer.

Warranty

This product is covered by a 20-year limited structural warranty with a 5-year finish warranty from the date of purchase.

Accessories

Hold Down Kit

PCSHLD

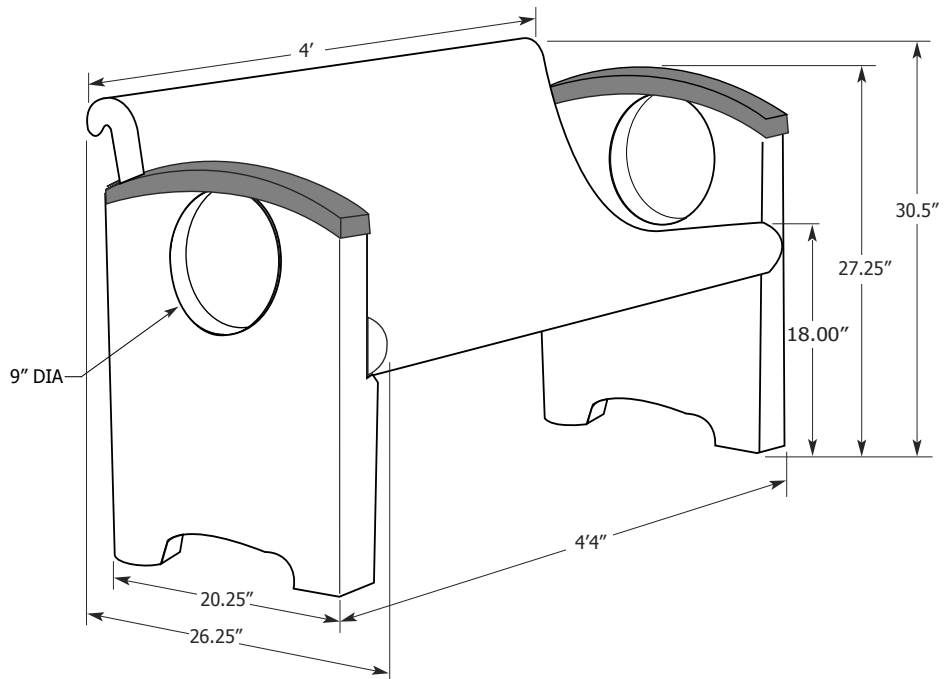

Shipping Information

Unit Wt.	Unit Shipping Wt. UPS	Unit Shipping Wt. Truck (1+ Units)	Unit Ship Size w/Pallet	Max Units per Pallet	Pallet Wt. (36" x 36")	Total No. Pkgs	Shipping Class
271 lbs	N/A	271 lbs/unit	25 cu. ft.	1	29 lbs	2	70