

LEXF4— Exposition 4' Flat Bench

4' flat bench with steel slat seat and portable/surface mount legs

Material

The 4' flat bench is composed of a 10-gauge steel slat seat with a .5" wide slot pattern and steel legs. The bench is 49.85" long and will support 200 lbs. per linear foot.

The bench is designed to be portable for flexibility in placement or surface mounted using predrilled .4" diameter holes in feet to prevent movement. Mounting hardware is not included.

Finish

Steel slat seat is protected by the patented Fusion Advantage™ finish. The plastisol coating has an average thickness of .125" and is encapsulated with a richly tinted, high performance powder coating that won't rust, fade, peel, chip, crack, mold or mildew. The finish has been tested to the requirements of ASTM E1354 and determined to be in compliance with California Uniform Fire Code 1103.2.1.4.2.

Fade-resistant, powder coated steel legs and under supports features a state-of-the-art primer proven to prevent rusting. Treated components exceed the industry standard by 34% in testing by independent sources.

Color

See website or sales representative for color choices.

Assembly

The bench requires some assembly. Stainless steel assembly hardware is included.

Maintenance

The product is virtually maintenance-free and requires only periodic cleaning with a sponge and a solution of mild detergent and water to remove surface dirt. Do not clean with solvent or petroleum base products.

Warranty

20-year limited structural warranty with 7-year finish warranty from the date of purchase

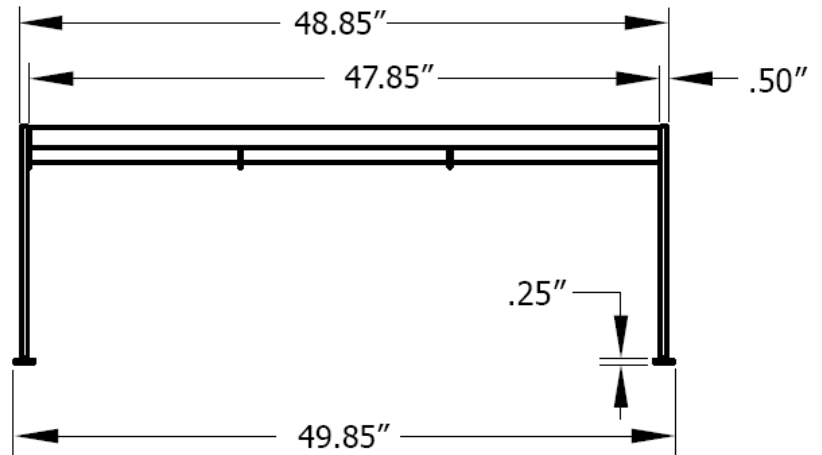
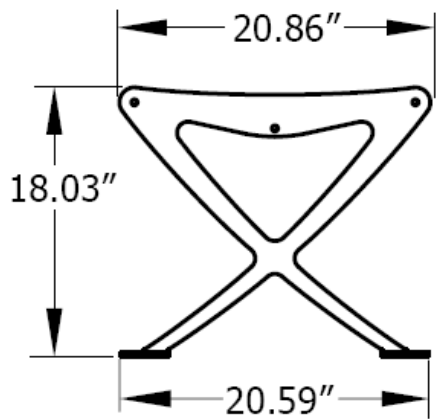

SHIPPING INFORMATION

Unit Weight	Unit Shipping Wt. UPS	Unit Shipping Wt. Truck (1+ Units)	Unit Ship Size w/Pallet	Max Units Per Pallet	Pallet Size/Wt. (32" x 48")	Total No. Pkgs.	Shipping Class
74 lbs.	N/A	80 lbs./unit	18 cu. ft.	6	50 lbs.	3	70