

**LEXC4— Exposition 4' Contour Bench**

**4' contour bench with steel slat seat, armrests and portable/surface mount legs**

**Material**

The 4' contour bench is composed of a 10-gauge steel slat seat with a .5" wide slot pattern and steel legs and armrests. The bench is 51.02" long and will support 200 lbs. per linear foot.

The bench is designed to be portable for flexibility in placement or surface mounted using predrilled .4" diameter holes in feet to prevent movement. Mounting hardware is not included.

**Finish**

Steel slat seat is protected by the patented Fusion Advantage™ finish. The plastisol coating has an average thickness of .125" and is encapsulated with a richly tinted, high performance powder coating that won't rust, fade, peel, chip, crack, mold or mildew. The finish has been tested to the requirements of ASTM E1354 and determined to be in compliance with California Uniform Fire Code 1103.2.1.4.2.

Fade-resistant, powder coated steel legs, armrests and under supports features a state-of-the-art primer proven to prevent rusting. Treated components exceed the industry standard by 34% in testing by independent sources.

**Color**

See website or sales representative for color choices.

**Assembly**

The bench requires some assembly. Stainless steel assembly hardware is included.

**Maintenance**

The product is virtually maintenance-free and requires only periodic cleaning with a sponge and a solution of mild detergent and water to remove surface dirt. Do not clean with solvent or petroleum base products.

**Warranty**

20-year limited structural warranty with 7-year finish warranty from the date of purchase

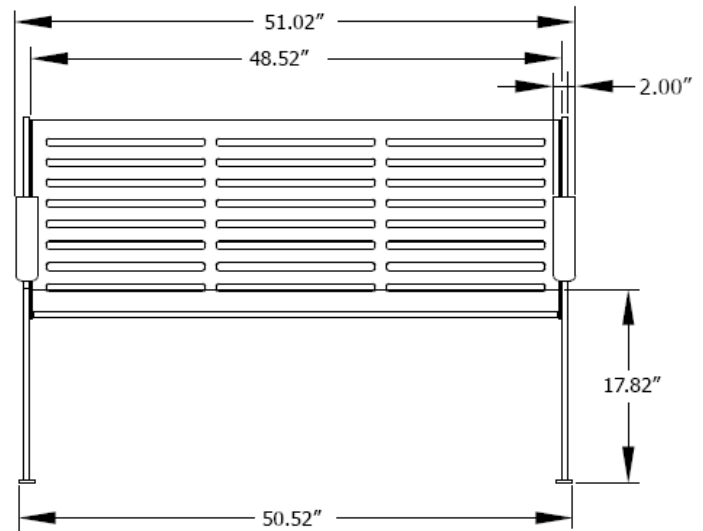
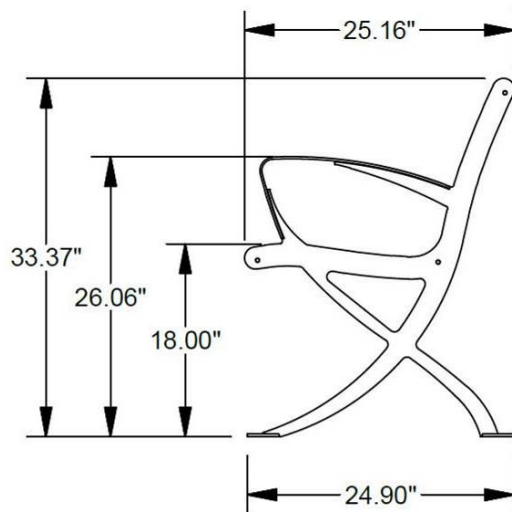

**SHIPPING INFORMATION**

Unit Weight	Unit Shipping Wt. UPS	Unit Shipping Wt. Truck (1+ Units)	Unit Ship Size w/Pallet	Max Units Per Pallet	Pallet Size/Wt. (32" x 48")	Total No. Pkgs.	Shipping Class
126 lbs.	N/A	139 lbs./unit	18 cu. ft.	6	50 lbs.	3	70