

F1365

ULTRA FLAT BENCH

6' expanded steel flat bench, rolled edge, with portable/surface mount

Material

The bench is 72.38" long. The flat bench seat is made of 3/4 #9 expanded steel with a diamond shaped pattern. The bench features a rolled edge and is protected by Fusion Advantage™, a plastisol coating with an average .125" thickness and a high-gloss powder coat. The bench seat will support 200 lbs per linear foot.

The legs are made of 2.38" O.D. steel tubing, protected by a fade resistant powder coat finish featuring a state of the art primer proven to prevent rusting. They are designed to be portable, allowing for flexibility in placement. The legs also have plates with predrilled holes for surface mounting to prevent movement (mounting hardware is not included).

Finish

Fusion Advantage is a heat fused plastisol coating that creates an impervious rustproof barrier and resists UV deterioration, mildew, staining and fading.

The finish has been tested to the requirements of ASTM E1354 and is determined to be in compliance with California Uniform Fire Code 1103.2.1.4.2.

A state of the art primer is applied to all of the under supports, providing extreme rust fighting protection and durability. Treated components exceed the industry standard by 34% in testing by independent sources.

Color

See website or sales representative for color choices.

Assembly

The bench requires some assembly. Stainless steel assembly hardware is included, purchaser must provide mounting hardware.

Maintenance

The product is virtually maintenance-free and requires only periodic cleaning with a sponge and a solution of mild detergent and water to remove surface dirt. Do not clean with solvent or petroleum based products.

Warranty

20-year limited structural warranty with 7-year finish warranty from the date of purchase. See full details on multi-year warranties for components at www.anovafurnishings.com/warranty.aspx.

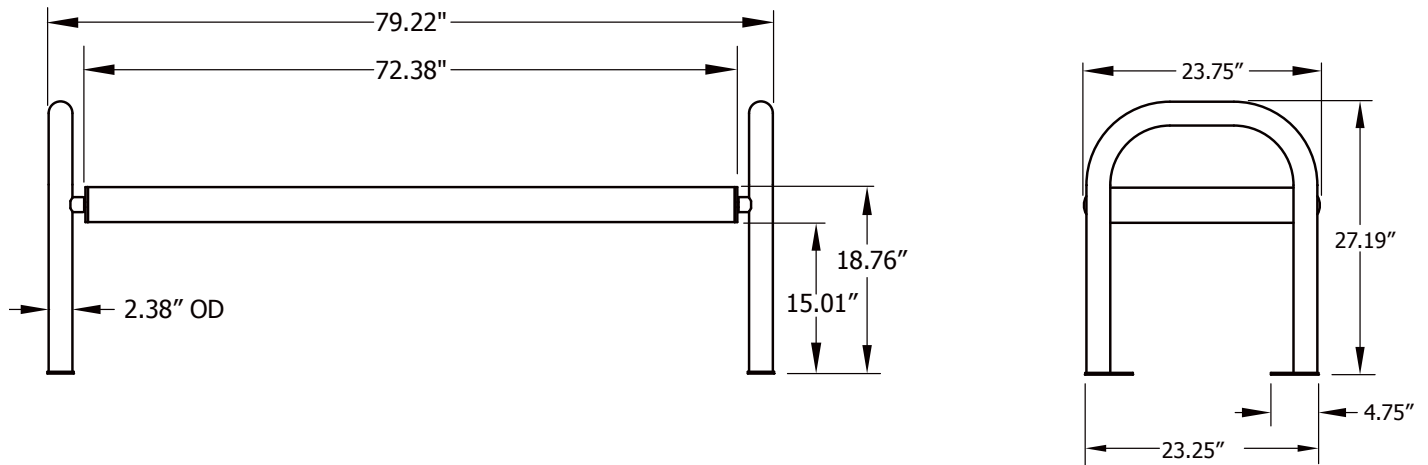

Shipping Information

Unit Wt.	Unit Shipping Wt. UPS	Unit Shipping Wt. Truck (1+ units)	Unit Ship Size w/Pallet	Max Units per Pallet	Pallet Wt. (74" x 32")	Total No. Pkgs	Shipping Class
122 lbs	N/A	135 lbs/unit	23 cu. ft.	5	100 lbs	2	70